

The image features a background of vertical stripes in red and white. A large, white, rounded oval shape is centered on the page, containing the word "POWERHOUSE" in a bold, black, sans-serif font. The oval has a slight shadow effect, making it stand out from the striped background.

POWERHOUSE

THE POWER OF POWERHOUSE.

**1.2MW OF MODULAR UPS IN A
STANDARD ISO CONTAINER.**

CONTINUOUS CRITICAL POWER

Reliable, predictable and repeatable power doesn't have to be complicated.

The Active Power POWERHOUSE is a factory-built and factory-tested enclosed Uninterruptible Power Supply (UPS) system designed for all types of environments.

With its simple and standardized design, rapid deployment, low cost and minimal on-site management requirements, the POWERHOUSE offers huge savings and genuine peace of mind.

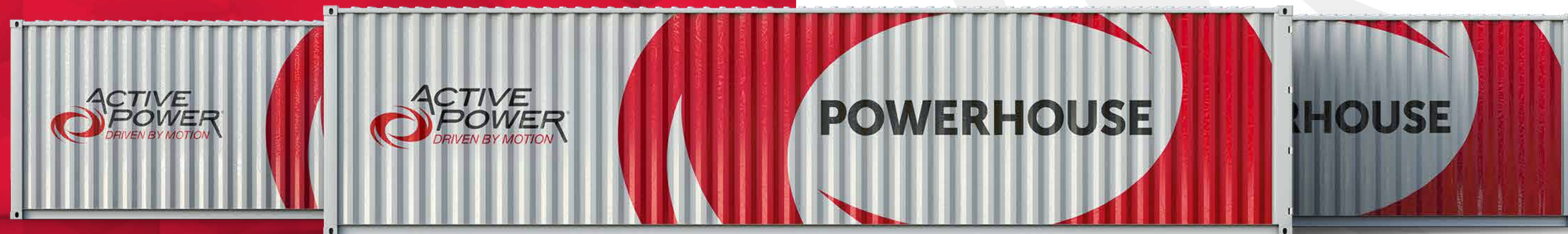

SIMPLY PLUG & PLAY.

4

PORTABLE & PREDICTABLE

Your system can be deployed almost anywhere in the world.

The controlled closed-cycle HVAC environment means that the POWERHOUSE can operate in most climates, with operating temperatures between -13 °F to 122 °F, and no issues in extreme humidity.

Designed and built inside a standard 40ft ISO corrosion-resistant steel container, your POWERHOUSE can easily be transported by truck, train or ship to your desired location and withstand 330lb/sqft snow load and 186mph winds on route and on site.

Thanks to our Plug and Play concept, minimal start-up commissioning and on-site management is required – your system can be up and running within days, rather than weeks.

Need to relocate? No problem. Your POWERHOUSE can be disconnected, transported to a new site, and fully operational again in no time.

“Operating temperatures
between -13°F to 122°F.”

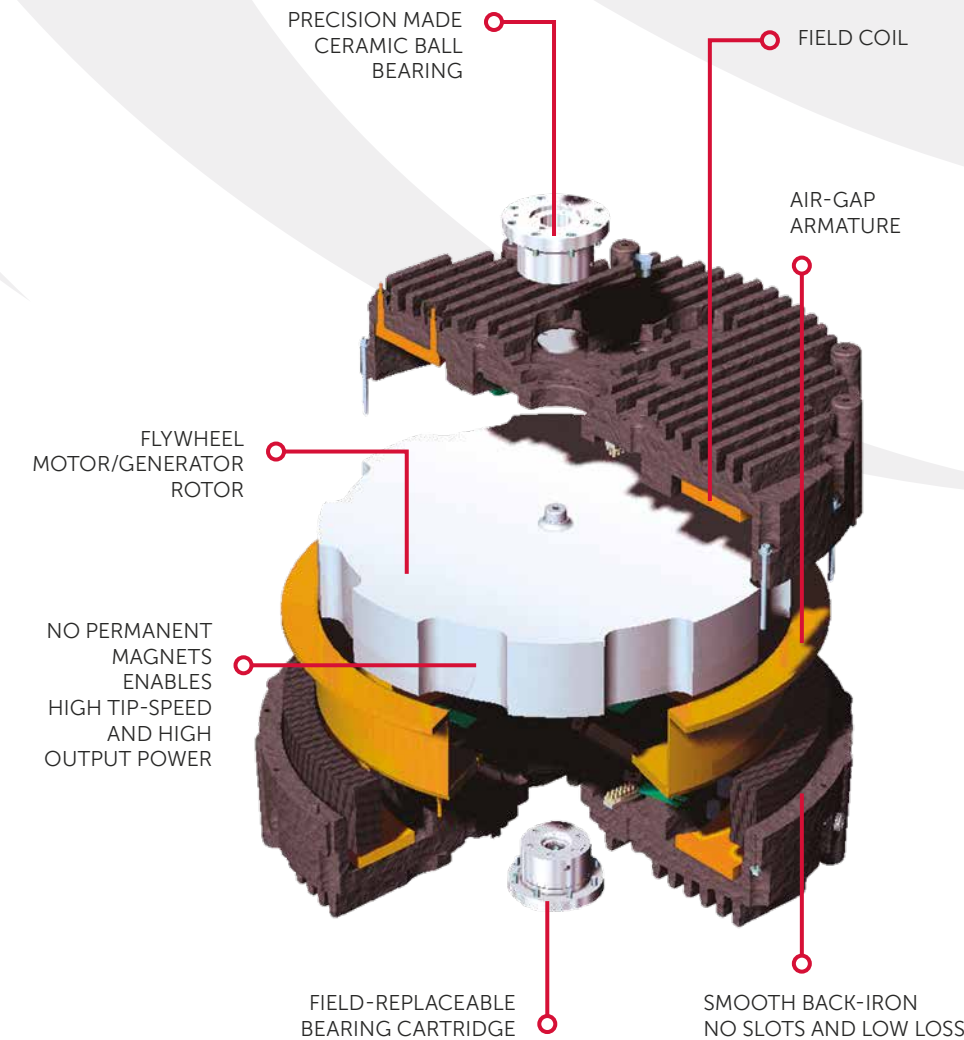

A UNIQUE FLYWHEEL

At the core of the POWERHOUSE sits Active Power's CLEANSOURCE® PLUS UPS, one of the most elegant, efficient and economical UPS's on the market.

Our unique and patented Active Power flywheel spins at 10,000 RPM, providing kinetic energy storage in place of traditional electrochemical batteries. This means less maintenance, lower cooling and space requirements, no cycle-life degradation during its 20 year operating life.

With over 5,000 Active Power flywheels deployed and spinning in over 50 countries, our field proven and highly fault-tolerant IGBT architecture protects critical loads every day worldwide in data center, healthcare, industrial and manufacturing applications.

The POWERHOUSE is available in a standard 1.2MW configuration and is customizable from 300kW up to 2.4MW, with N+1 options up to 2.1MW. It is constructed to be fully scalable, enabling you to expand your backup power infrastructure on demand.

“Field proven and
highly fault tolerant.”

5

INSIDE THE POWERHOUSE

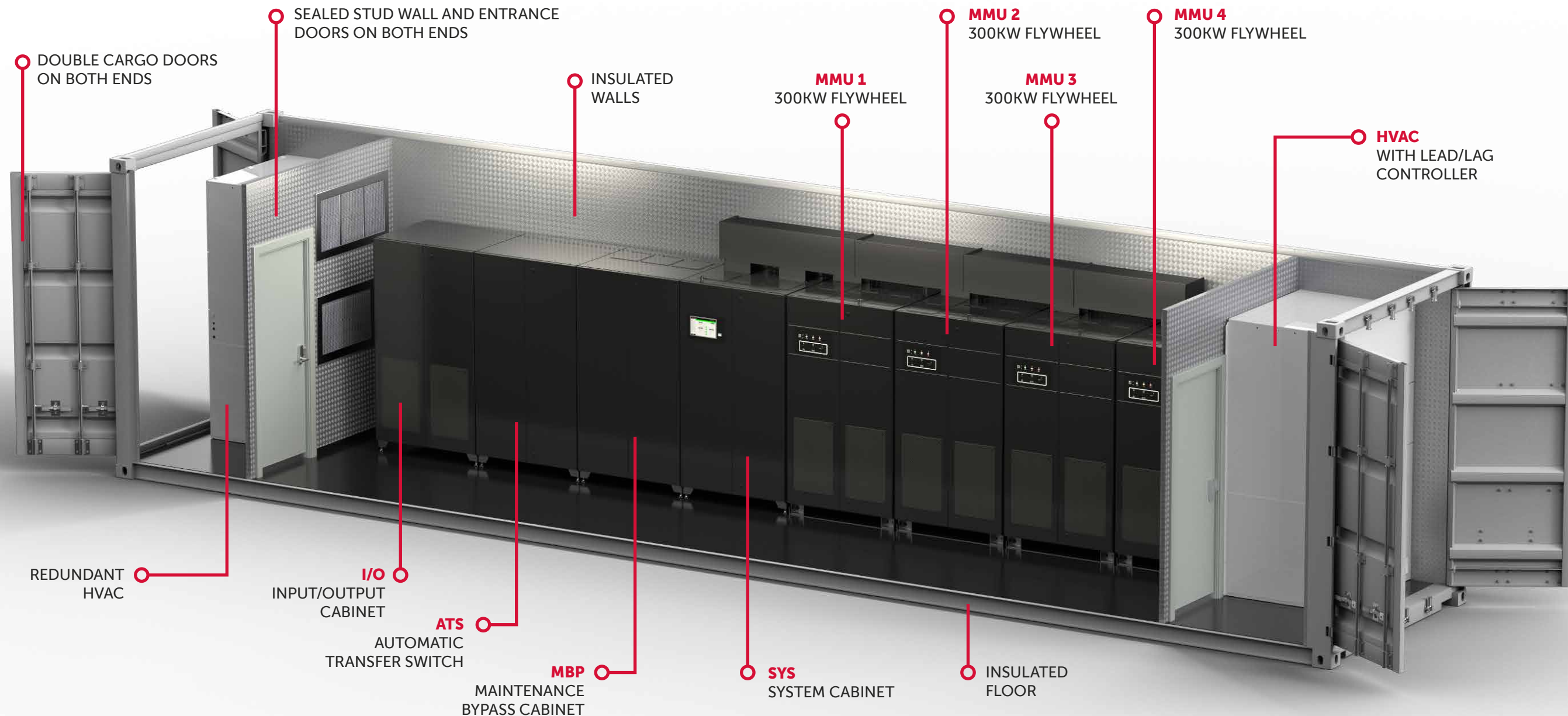

KEY FEATURES

- 300kW UPS BUILDING BLOCKS
- PARALLEL UP TO 2400kW
- UPS UP TO 98% EFFICIENT
- BATTERY FREE
- HALF THE SPACE OF LEGACY BATTERY BASED UPS
- REDUNDANT UPS FANS AND CONTROL POWER
- HIGH EFFICIENCY, REDUNDANT HVAC
- FIRE DETECTION
- OPTIONAL GAS FIRE SUPPRESSANT
- CORROSION-RESISTANT STEEL
- 13°F TO 122°F OPERATING TEMPERATURE
- 186mph WIND RATING
- 330lb/sqft SNOW LOAD
- FACTORY ASSEMBLED AND TESTED
- LOW COST SHIPPING
- RAPID SITE DEPLOYMENT
- GENERATOR COMPATIBILITY
- 20-YEAR DESIGN LIFE

LESS IS MORE.

LESS SPACE

Real estate costs real money.

The Active Power POWERHOUSE delivers one of the most power-dense energy supply systems in the industry, all from within the four walls of a 40ft ISO container. Eliminating temperature controlled battery rooms not only decreases energy bills, but also frees up white space inside your building for more critical infrastructure.



A perfect fit: The CLEANSOURCE® PLUS MMS UPS takes up less space than comparable battery UPS, allowing room for up to 1.2MW of UPS and equipment inside a standard container.

“Frees up white space for more critical infrastructure.”

LESS COST

Factory engineering, assembly and testing of your POWERHOUSE yields dramatic efficiencies, and can save you as much as 40% on capital expenditures compared to conventional brick and mortar construction.

Our Plug and Play design means there is no need to put time, money and energy into building a covered space for your UPS. Your POWERHOUSE is ready to go as soon as it's delivered.

With one of the highest UPS efficiencies at 98%, lower service and maintenance costs, and never having to replace or cool batteries, your Total Cost of Ownership (TCO) sits at 32% less on day one and 36% lower over a 20 year lifespan when compared to a Static UPS with Lithium Batteries in a traditional brick and mortar electrical room.

“With efficiencies at 98% and lower service and maintenance costs, your TCO sits at 32% less on day one.”

Accumulated Deployment Expenses

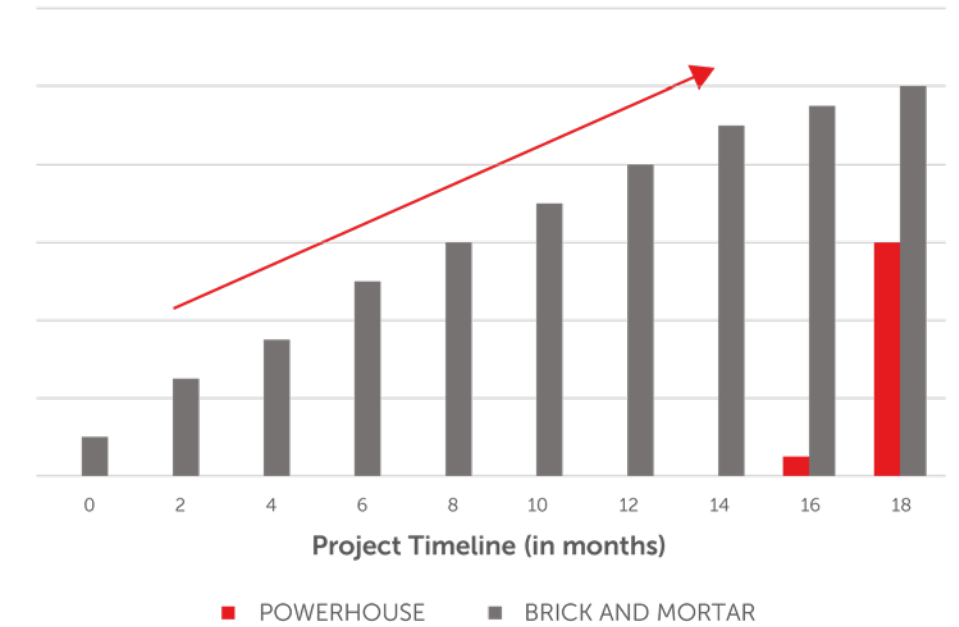

Total Cost of Ownership

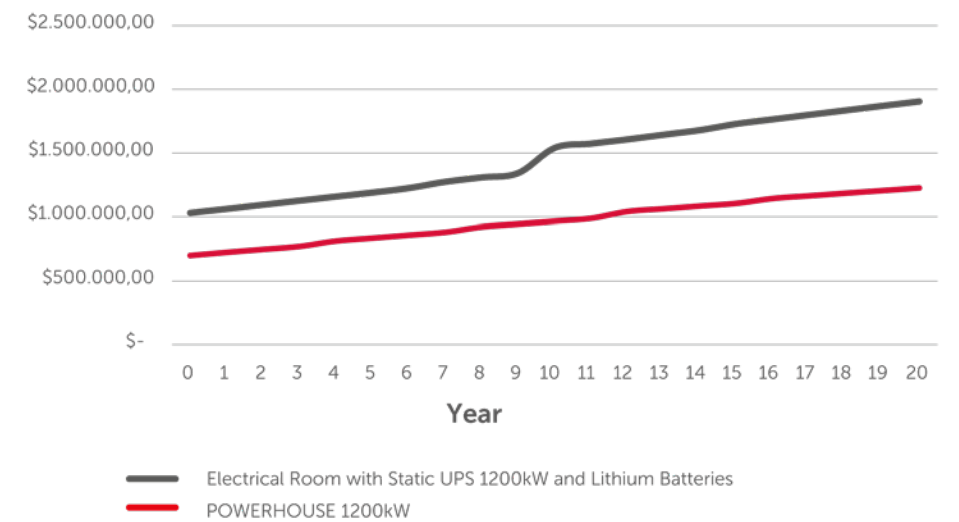

LESS ENERGY

Active Power's high efficiency UPS architecture is the core building block of the POWERHOUSE system, requiring just 4.4kW to spin all four wheels in your 1200kW system.

For example, even at a 50% loading, our CLEANSOURCE® PLUS 300kW UPS efficiency sits at 97%, which is 2% higher than typical battery based UPS systems. Unlike battery systems, as the load increases, so does our efficiency.

Batteries NOT included.

With your battery-free POWERHOUSE, you will achieve significant savings in maintenance, operations and space. Eliminating temperature controlled battery rooms reduces energy consumption and diminishes the risk of chemical fires. Never having to replace, recycle or even think about batteries ever again gives you real peace of mind – for your business and for the environment.

“Never replace, recycle or even think about batteries ever again.”

LESS CARBON

Up to 35% less carbon emissions

With an increase in concern for our planet and business efforts to reduce environmental impact globally,

Active Power is proud to offer a solution that produces considerably lower carbon emissions than any other UPS on the market. For example, over its 20-year lifespan, POWERHOUSE will produce up to 35% less carbon emissions than a static UPS with lithium batteries in an electrical room.

Cumulative Carbon Footprint (tonnes of CO₂)

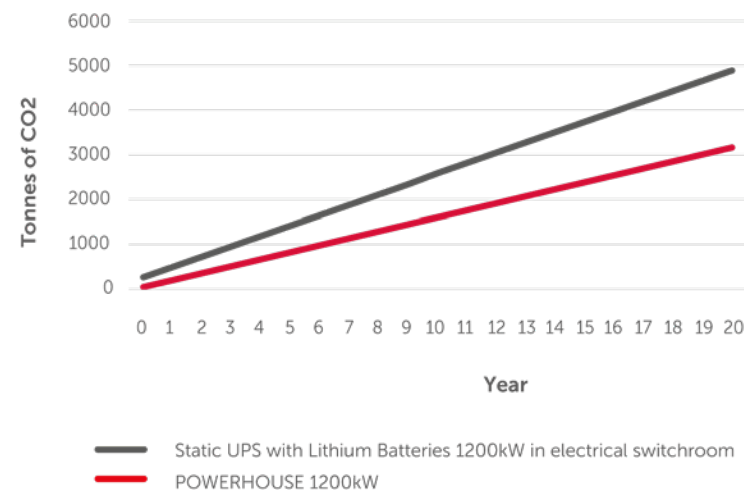

GOOD FOR YOUR BUSINESS, GOOD FOR THE WORLD.

LESS COMPLEXITY

One of the most compelling benefits of a POWERHOUSE solution is single source accountability.

The Active Power team set out to eliminate the time, cost and uncertainty inherent to delivery, testing, integration and commissioning when installing a UPS.

The POWERHOUSE is engineered, assembled and tested at our ISO 9001 certified factory in Austin, Texas, taking the guess-work and unknowns out of the installation and commissioning phases.



| BRICK&MORTAR DEPLOYMENT | | POWERHOUSE DEPLOYMENT | | |
|-------------------------|-------------|-----------------------|-------------|---------------------|
| Factory work | Onsite work | Factory work | Onsite work | |
| | X | X | | ENGINEERING |
| | X | X | | COMPONENT LOGISTICS |
| | X | X | | TESTING |
| | X | X | | INSTALLATION |
| | X | | X | SITE TESTING |
| | X | | X | COMMISSIONING |

“Engineered, assembled and tested at our ISO 9001 certified factory in Austin, Texas.”

LESS RISK

When your facility takes a power hit you can rely on Active Power to be there.

The POWERHOUSE is designed to be less costly, less complex, take up less critical real estate and be more energy efficient, but above all, we strive to protect your investments with reliable, predictable and continuous operation.

Active Power UPS systems have 250+ million hours of field runtime in over 50 countries, including some of the harshest environments in the world.

Complete monitoring and control software provides real-time system visibility from virtually anywhere to improve your awareness of power related events.

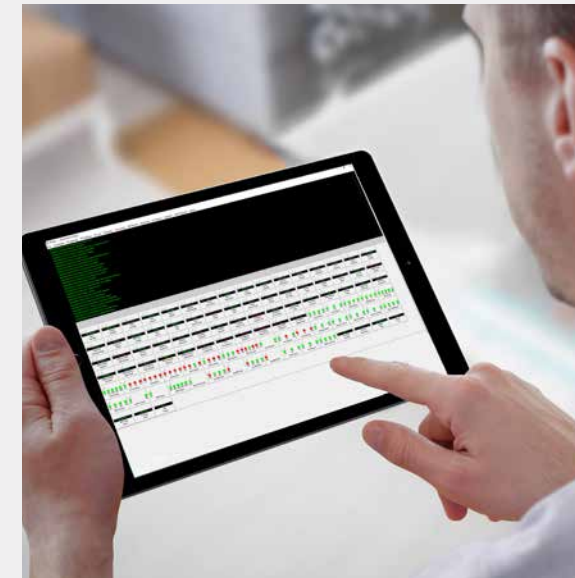

“250+ million hours of field runtime in over 50 countries.”

PROTECTING YOUR INVESTMENT

Regular maintenance and service prevents potential small problems from becoming issues that could cause costly downtime.

Active Power has designed our UPS products with ease of maintenance in mind to ensure your critical power infrastructure operates with the utmost reliability. Unlike battery systems, which sometimes require monthly or quarterly inspections to ensure reliability, CLEANSOURCE® UPS requires simple, non-invasive annual maintenance and a very simple periodic bearing change. This streamlined maintenance schedule both restores your UPS to factory-like condition and reduces downtime during its operating life, improving the availability of your mission critical operations.

Active Power offers flexible service plans designed to meet individual customer needs over the life of the system. Select the plan tailored to best meet your needs and be assured that everything will be taken care of by our qualified Active Power service team.

“Flexible service plans designed to meet individual customer needs.”

“Simple, non-invasive annual maintenance.”



ALWAYS
ON.
ALWAYS
READY.



Active Power Inc. 2128 West Braker Lane, Austin, TX 78758

Piller Australia | Piller China | Piller France | Piller Germany | Piller India | Piller Italy | Piller Singapore | Piller Spain | Piller UK | Piller USA

Active Power Inc. is a division of the Piller group

www.activepower.com